

SURFACE MINE DESIGN

Izhar Mithal Jiskani

This course describes the techniques involved in the exploitation of a geological deposit by surface mining.

CONTENTS

| | |
|---|----|
| BACKGROUND | 1 |
| 1. Surface mining methods | 1 |
| 2. Open pit planning and design | 4 |
| 3. Advantages of surface mining..... | 7 |
| 4. Disadvantages of surface mining..... | 7 |
| 5. Open pit terminology | 8 |
| 6. Stripping ratio | 10 |
| 7. Factors governing strip mining | 12 |
| 8. Calculation of overburden ratio | 14 |
| 9. Initial data collection checklist..... | 15 |
| 10. Planning phase | 16 |
| 11. Orebody description | 20 |
| 12. Ore reserve calculation | 22 |
| 13. Geometrical considerations | 33 |

BACKGROUND

The method of mining is unique for each different size and each shape of the orebody. Mineral deposits differ in the shape and orientation of an orebody, the strength of the ore and surrounding rock, and the type of mineral distribution. These geological features influence the selection of a mining method and the plan for the ore development. Operating mines vary in size from small underground mines (with production under 100 tonnes of mineral a day) to large open pits excavating tens of thousands of tonnes of ore a day (Whyte and Cumming, 2007). Open pit mining is applied to the extraction of near-surface deposits.

1. SURFACE MINING METHODS

If a mineral deposit lies close to the surface, is of sufficiently big size, surface mining (an open-pit mine) can be the most suitable method to extract the ore (Whyte and Cumming, 2007). Surface mining is the exploitation method in which minerals are mined from the surface. It seems to be the most commonly used mining method in the world.

Surface mining is two-step operations;

1. Overburden removal (stripping)
2. Mining of deposit

Overburden is stripped from benches to uncover the deposit and transported to a dump at some point remote from the operation itself.

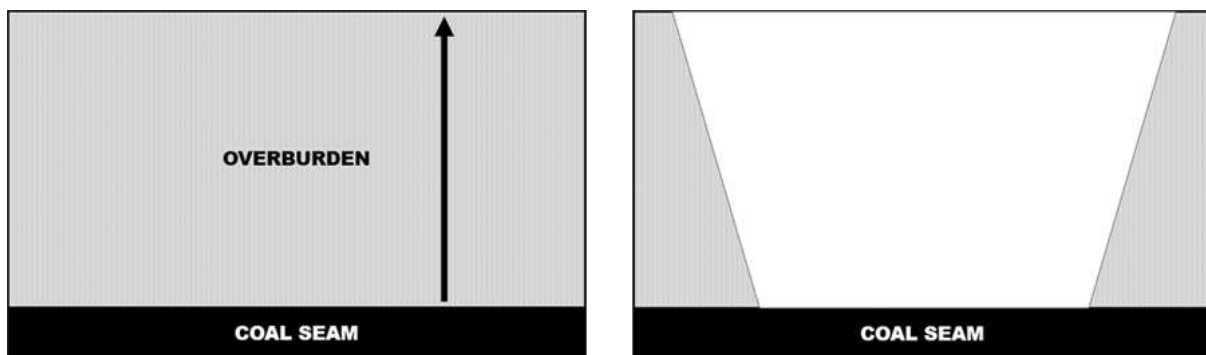

When any deposit is extending beyond the break-even depth (i.e. the depth at which cost of mining is equal to price fetched), which could be attained by any of the surface mining methods; the underground mining could be applied.

In open-pit mining, a thick deposit is mined in benches or steps. However, a comparatively thin deposit may be excavated from a single face as in the case of quarrying, augering and open cast mining. In the case of these methods, a large capital investment is necessary, however, they can provide

- high productivity,
- low operating costs, and
- satisfactory safety conditions.

Prior to or during mining, it is necessary to remove any overburden by a stripping operation. Open pit or open cast mining is used to mine a mineral deposit close to the earth's surface that is of

- low stripping ratio,
- shows large extension, and
- is fairly uniform.

It should be noted here that a stripping ratio of 2 to 1 means that there is twice as much waste rock mined as mineral (ore, coal, etc.).

Two types of methods may be used in surface mining: mechanical extraction and aqueous extraction.

1.1 Mechanical Extraction Methods

The mechanical extraction involves mechanical processes to obtain minerals from the earth. There are four mechanical extraction methods:

(1) open pit mining,

An open pit mine is the mine to exploit the deposits which are outcropping to the surface or those which are confined (limited) to a shallow (low) depth, and the waste rock lying above (overburden) is removed and transported away from the place of their deposition.

(2) open cast mining,

Opencast is also a surface mine to mine out the flat deposits but the overburden is backfilled in the worked-out area. In open cast (or strip) mining, overburden

is removed by casting into mined-out areas, and mineral is excavated in consecutive operations.

(3) quarrying,

The term quarrying, of course, is very loosely applied to any of the surface mining operations but it should be confined to a surface mining method to mine out the dimensional stones such as slate, marble, granite etc. Quarrying is a highly specialized small-scale method, slow and the costliest of all mining methods. Only square set stopping method is as much expensive as quarrying.

(4) auger mining.

Auger mining is a surface mining technique used to recover additional coal from a seam located behind a highwall produced either by stripping or open-pit mining. Augering is employed to recover coal from the highwall at the pit limit. This method is also specialized but involves low costs.

1.2 Aqueous Extraction Methods

The deposits are sometimes located near the surface datum but covered by an aqueous body such as a lake, tank, river, or even by seawater. Mining of such deposits is also a part of surface mining practices. These are known as aqueous extraction methods.

The aqueous extraction methods must be provided with the access to water or an aqueous mixture during mining and processing. They recover the valuable mineral by jetting, slurring, melting or dissolving.

There are of two types of these methods:

(1) Placer mining

Placer mining is used to mine mineral deposits that are not consolidated (combined/joined), such as sand, gravel or alluvium in which a valuable heavy mineral exists freely. It is an ancient method of using water to excavate, transport, concentrate, and recover heavy minerals from alluvial or placer deposits. Valuable heavy minerals such as diamonds, native gold, native platinum, and titanium can be found in placer form.

(2) Solution mining methods

Solution mining employing surface or in situ techniques is used for deposits of minerals that can be excavated by dissolution as well as by melting, leaching, or slurring. The two methods are similar. Surface leaching employs heap or dump leaching of mineral values; copper, gold, and uranium are the examples. In situ mining uses water to dissolve, melt or slurry the minerals. The Barren solution is introduced down one set of wells and the loaded solution returns to the surface through concentric or another set of wells. This mining method is mainly used with sulphur, evaporate, or water-soluble minerals. In situ leaching utilizes chemical or bacteriological reagents, usually mixed with water to selectively dissolve the valuable minerals. Drill holes are used to inject and recover the solution

2. OPEN PIT PLANNING AND DESIGN

An open pit mine is an excavation or cuts made at the surface of the ground to extract ore which is open to the surface for the mine's operational time. In order to expose and mine the deposit, significant quantities of waste rock have to be excavated and relocated (moved). As the lowest possible costs with maximum profits are highly expected, the planning of an open pit mine is closely related to economics, which in turn is influenced by several geologic and mining engineering conditions.

Surface mining is considered more advantageous than underground mining in relation to

- recovery,
- grade control,
- economy,
- flexibility of operation,
- safety, and
- the working environment.

However, there are many deposits that are too small, irregular, and/or deeply buried to be extracted economically by surface mining methods. Moreover, even where mineralization goes to a greater depth in open pit mines, the increasing amount of

overburden to be handled can make mining unprofitable. In such the situation, mining has to be either abandoned or converted from the surface to underground operations. Furthermore, the selection of excavation methods and equipment is more complex for surface mining than for underground mining. In surface mining, blasting patterns have to be properly planned to get adequate fragmentation of overburden.

Open pit design is elaborated in several stages that consist of devising (planning) a scheme or set of alternative schemes, followed by an evaluation and selection of the optimum scheme. The most economic final pit design depends on factors that cannot be controlled by the mining engineer such as the

- geometric outline of the ore body,
- the distribution of ore within the ore body,
- topography,
- maximum allowable slope angles, etc.

However, the economics of the mining program is related to the factors determined by the mining engineer such as the choice of mining ratio, production rates, and equipment.

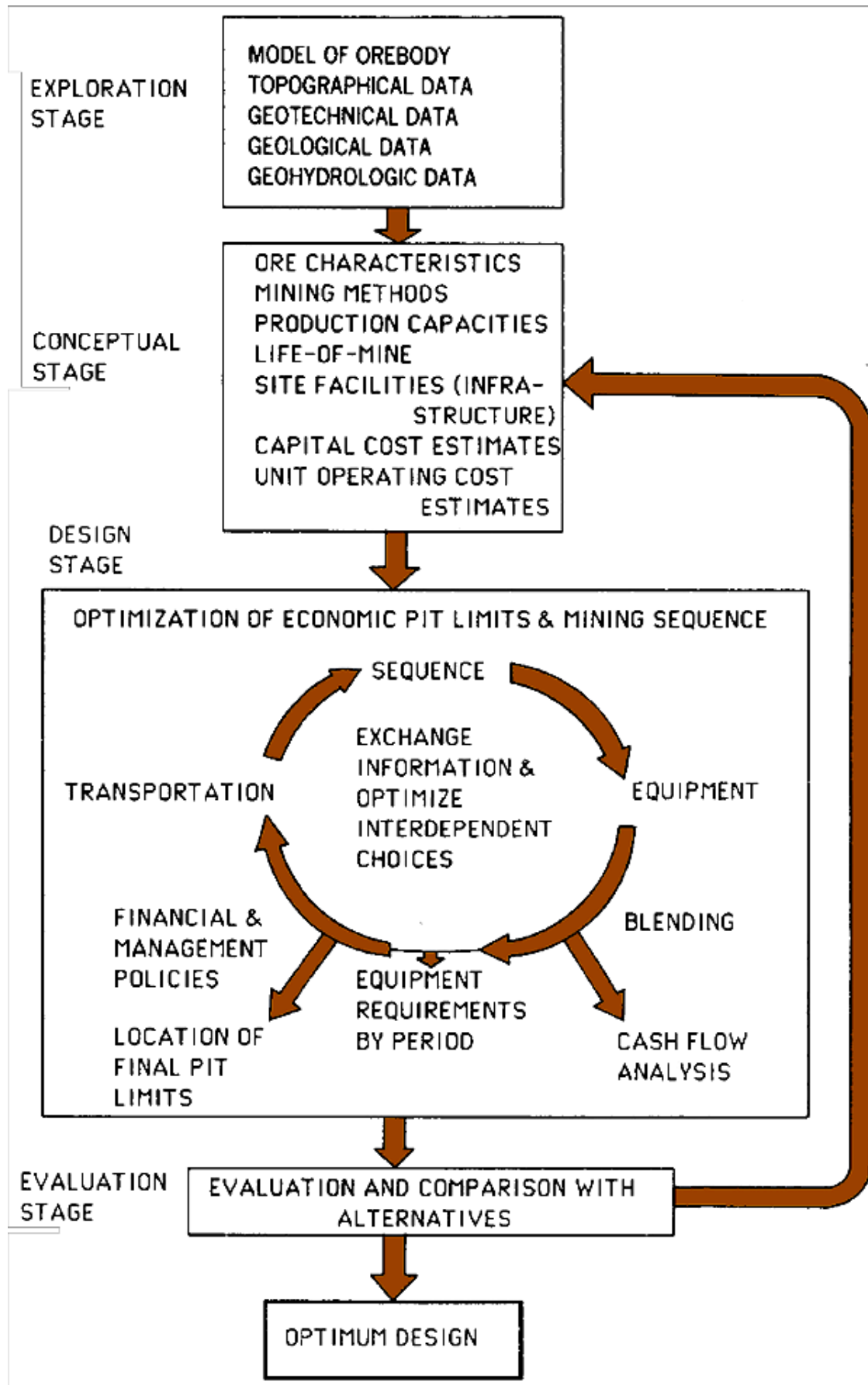

Fig: Diagrammatic presentation of the design process (after Fourie, 1992)

3. ADVANTAGES OF SURFACE MINING

1. Higher Productivity

•Due to:

- Greater degree of mechanization
- Larger equipment (economies of scale)
- Few personnel

2. required Lower operating

costs per ton Due to:

- Higher productivity
- Easier material handling
- Lower grade deposits can be mined

3. Reduced development time

- More favorable cash flow and quicker repayment of capital investment.
- Greater geological certainty.
- Safer operations

4. DISADVANTAGES OF SURFACE MINING

1. Large proportion of waste to ore.
2. High level of environmental impact.
3. Affected by climatic conditions.
4. Depth limit

5. OPEN PIT TERMINOLOGY

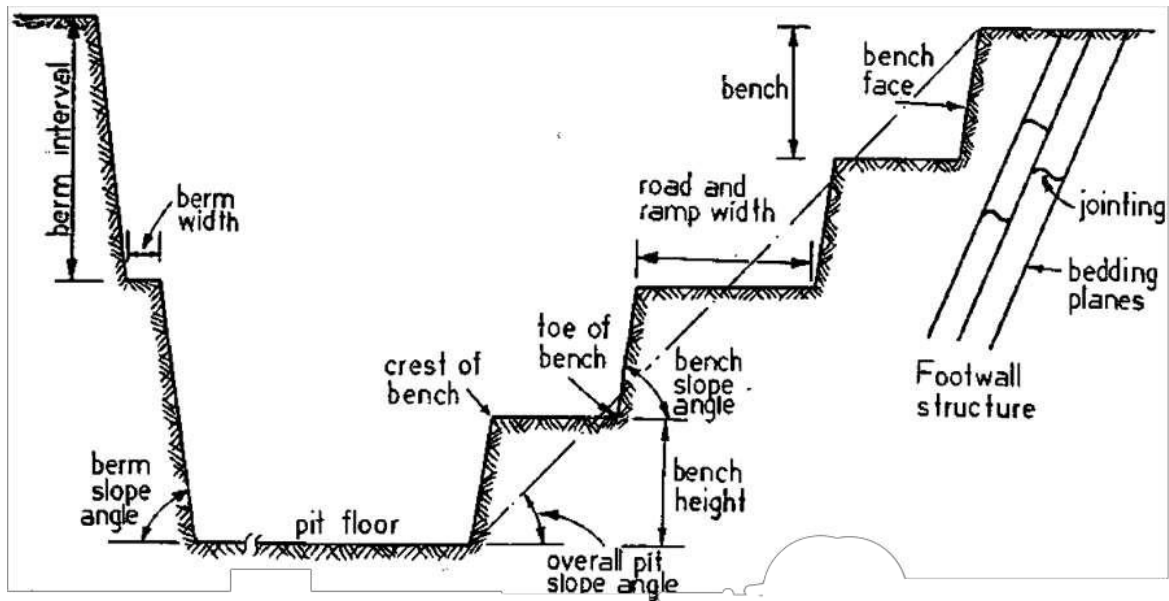

BENCH: Ledge that forms a single level of operation above which mineral or waste materials are mined from the bench face.

Bench height: vertical distance between upper and lower surfaces of a bench. It is influenced by the size of the equipment, mining selectivity, government regulations and safety.

Bench width: a distance between crest and toe.

Face angle: An inclination of a face of the bench w.r.t horizontal.

Crest: is an upper point of a bench face.

Toe: is a lower point of a bench face.

BENCH SLOPE OR BANK ANGLE: Horizontal angle of the line connecting bench toe to the bench crest.

BERM: Horizontal shelf or ledge within the ultimate pit wall slope left to enhance the stability of a slope within the pit and improve the safety. Berm interval, berm width and berm slope angle are determined by the geotechnical investigation.

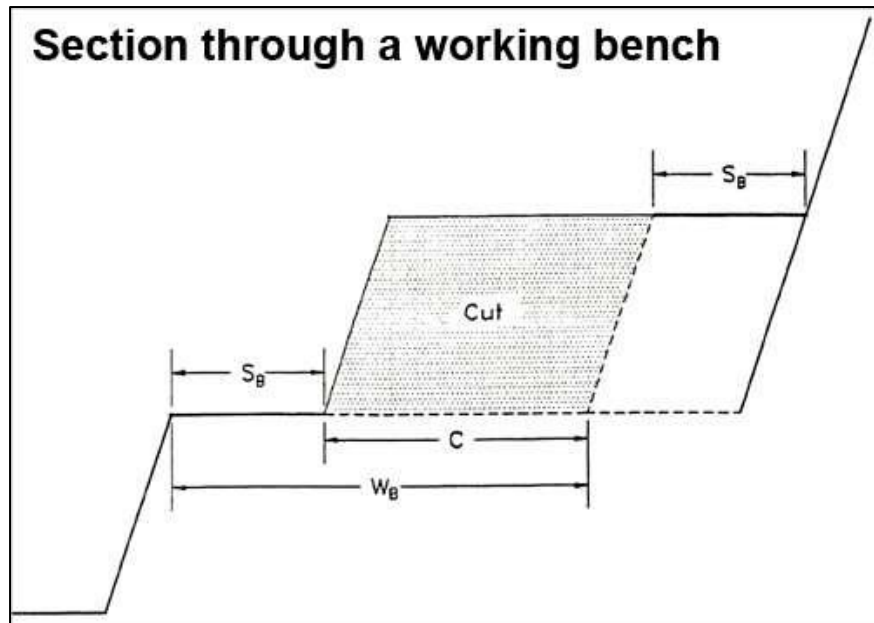

A working bench is one that is in the process of being mined.

Cut: The width being extracted from the working bench is called the cut.

Width of working bench (W_B): It is defined as the distance between the crest of the bench and the new toe position after the cut has been made.

Overall pit slope angle: The angle measured from the bottom bench toe to the top bench crest. It is the angle at which the wall of an open pit stands, as measured between the horizontal and an imaginary line joining the top bench crest with the bottom bench toe. It is determined by rock strength, geologic structures and water conditions. The overall pit slope angle is affected by the width and grade of the haul road.

HAUL ROADS: During the life of the pit, a haul road must be maintained for access.

During the life of open pit mining, a **haul road** must be maintained into the pit. A spiral system is an arrangement in which the haul road is arranged spirally along the perimeter (border) walls of the pit so that the gradient (incline) of the road is more or less uniform from the top to the bottom of the pit.

Haul road width is governed by the required capacity of the road and type of haulage unit.

The **grade** may be defined as the inclination of the road in terms of degrees from the horizontal or percentage of rise to the horizontal.

Angle of repose or angle of rest: maximum slope at which a heap (pile) of loose material will stand without sliding.

The **sub-outcrop depth** represents the depth of waste that has to be removed before any ore is exposed. This waste is often referred to as pre-production stripping.

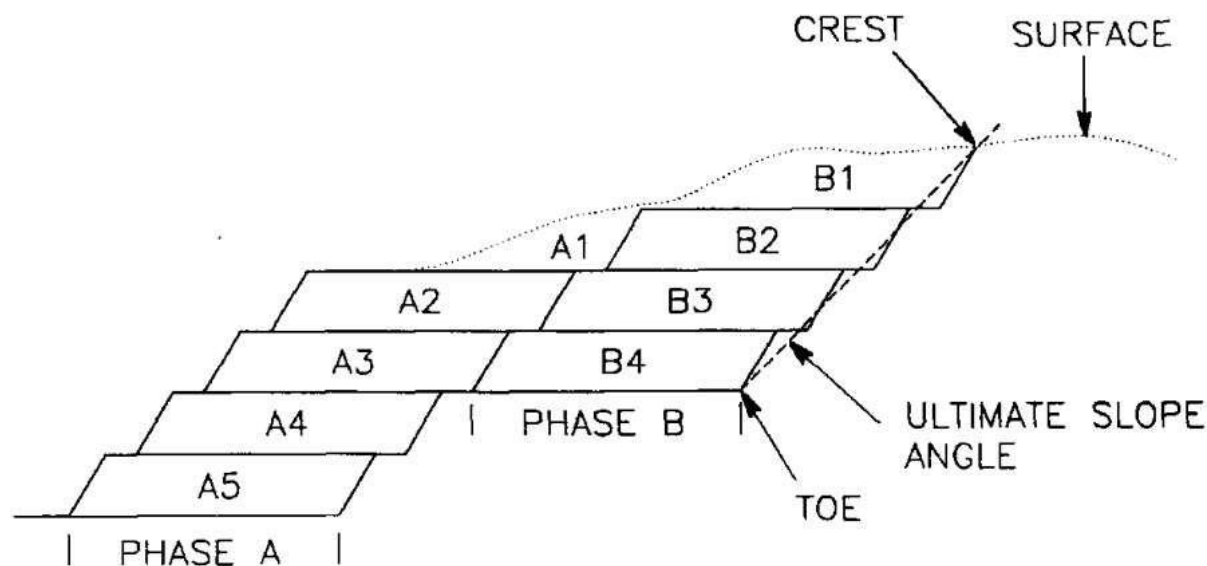

Fig. Cut sequence for conventional pushbacks.

6. STRIPPING RATIO

It is the ratio of
 Overburden + inter-burden thickness
 to the
 Cumulative thickness of coal seams

It is a critical and important parameter in pit design and scheduling. Stripping ratio refers to the ratio of the volume of overburden (or waste material) required to be removed to the volume of ore recovered. Expressed in tons of waste to tons of ore in hard rock open pit operations.

For example, a **3:1** stripping ratio means that mining one *cubic meter of ore* will require mining *three cubic meters of waste rock*.

AVERAGE STRIP RATIO: Total waste divided by total ore within the ultimate pit.

CUTOFF STRIPPING RATIO: Costs of mining a ton of ore and associated waste equals to net revenue from the ton of ore.

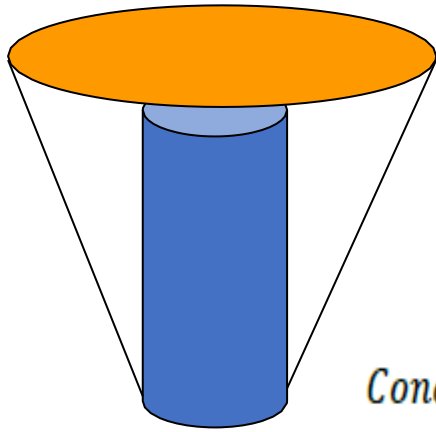

$$Cone = \frac{1}{3} Base * Height$$

6.1 Determination of Stripping Ratio

COAL SEAMS: DRILLED HOLE BP-01, BLOCK-XI

| COAL SEAMS | | | | |
|------------|-------------|--------------|-----------------|-------------------------|
| Sr. No | Seam Number | Top (meters) | Bottom (meters) | Coal Thickness (meters) |
| 1 | 1 | 227.70 | 228.48 | 0.78 |
| 2 | 2 | 231.10 | 232.86 | 1.76 |
| 3 | 3 | 235.36 | 235.84 | 0.48 |
| 4 | 4 | 244.20 | 245.43 | 1.23 |
| 5 | 5 | 245.98 | 246.46 | 0.48 |
| 6 | 6 | 247.16 | 250.43 | 3.27 |
| 7 | A | 250.75 | 251.00 | 0.25 |
| 8 | 7 | 256.16 | 257.04 | 0.88 |
| 9 | 8 | 261.26 | 261.49 | 0.23 |
| 10 | 9 | 275.78 | 276.68 | 0.90 |
| Total | | | | 10.26 |

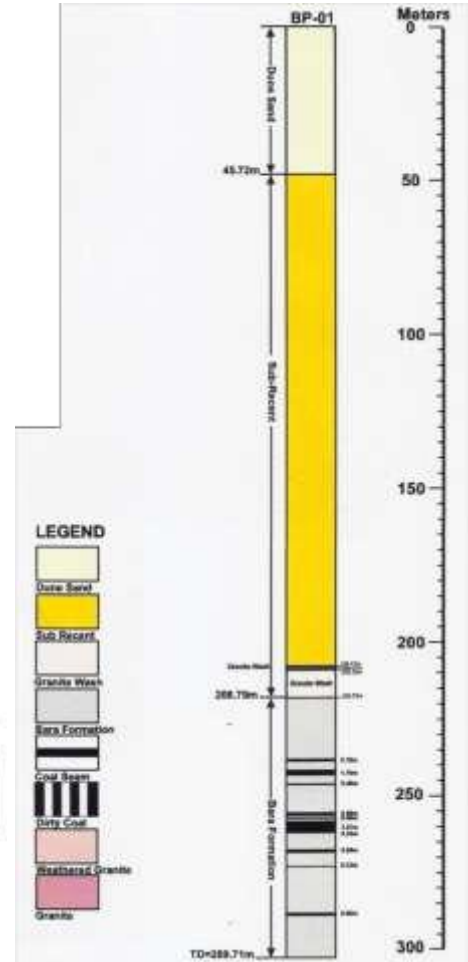

Overburden thickness = 227.7 m
 Cumulative coal thickness = 10.26 m
 Inter-burden thickness = 276.68 – (227.7 + 10.26)
 = 38.72 m

$$SR = \frac{Overburden\ thickness + Interburden\ thickness}{Cummulative\ coal\ thickness}$$

$$SR = \frac{227.7 + 38.72}{10.26} = 25.97$$

Breakeven Stripping Ratio: It is the stripping ratio at which cost of mineral is the same as the mining cost (Zero profit).

7. FACTORS GOVERNING STRIP MINING

"Strip mining" is the practice of mining a seam of mineral, by first removing a long strip of overlying soil and rock (the overburden). It is most commonly used to mine coal and lignite (brown coal). Strip mining is only practical when the ore body to be excavated is relatively near the surface.

Factors governing strip mining are;

- a) How much coal is to be mined?
- b) What is the overburden ratio?
- c) Reclamation considerations.

Example 1: Consider a property having a 4 ft. coal seam. Specific gravity of the coal is 1.28. What area must be stripped to maintain a clean coal production level of 10,000 tons per day when the recoverable coal is estimated at 80%.

Solution

- **Specific gravity of coal = 1.28**

Convert the S.G into density (Density of coal = SG of coal multiplied by density of water)

$$\begin{aligned} \bullet \text{Density of coal} &= 1.28 \times 62.428 \text{ lb/ft}^3 \\ &= \mathbf{80 \text{ lb/ft}^3}. \end{aligned}$$

Determine the volume of one ton coal

$$\text{Weight} = \text{Volume} \times \text{Density}$$

$$\text{Volume} = \text{Weight}/\text{Density}$$

- 1 ton of coal (2000 lb) occupies a volume of $2000 / 80 \text{ ft}^3 = \mathbf{25 \text{ ft}^3}$
- 10,000 tons of coal will occupy $10,000 \times 25 \text{ ft}^3 = \mathbf{250,000 \text{ ft}^3}$.

- **Recovery of coal = 80% $\Rightarrow 80/100 = 0.8$**

$$\text{Required volume of coal to be uncovered} = 250,000 / 0.8 = \mathbf{312,500 \text{ ft}^3}.$$

•Coal seam thickness = 4 ft

•Required area for stripping = $312,500 / 4$

$$= 78,125 \text{ ft}^2 \quad \therefore 1 \text{ ft}^2 = 0.111111 \text{ sq. yds.}$$

$$= 8680 \text{ sq. yds} \quad \therefore 1 \text{ sq. yds.} = 0.000206612 \text{ acre}$$

$$= 1.79 \text{ acres}$$

Conclusion: In order to achieve the production target of 10,000 tons/day, with a 4 ft. thick coal seam, the area of 1.79 acres is to be stripped.

Example 2: Consider a property having a 6 ft. coal seam. Specific gravity of the coal is 1.19. What area must be stripped to maintain a coal production level of 10,000 tons per day when the recoverable coal is estimated at 85%.

• Specific gravity of coal = 1.198

• Density of coal = $1.19 \times 62.428 \text{ lb/ft}^3$

$$= 74.29 \text{ lb/ft}^3.$$

• 1 ton of coal (2000 lb) occupies a volume of $2000/74.29 \text{ ft}^3 = \mathbf{26.92 \text{ ft}^3}$.

• 10,000 tons of coal will occupy $10,000 \times 26.92 \text{ ft}^3 = \mathbf{269,200 \text{ ft}^3}$

•Recovery of coal = 85% = 0.85

•Required volume of coal to be uncovered = $269,200 / 0.85 = 316,705.88 \text{ ft}^3$.

•Coal seam thickness = 6 ft

•Required area for stripping = $316,705.88/6$

$$= 52,784.31 \text{ ft}^2. = 5,864.92 \text{ sq. yds}$$

$$= 1.21 \text{ acres}$$

Conclusion: In order to achieve the production target of 10,000 tons per day, with a 6 ft. thick coal seam, the area of 1.21 acres is to be stripped.

8. CALCULATION OF OVERBURDEN RATIO

It is a volume of overburden above 1 ton of coal.

Considering the previous example-01, suppose the overburden cover is 50 ft.

- 1 ton of coal occupies the volume of 25 ft³.
- 4 ft. thick coal seam occupies the area of $25/4 = 6.25$ ft².

Thus, the volume of overburden above 1 ton of coal = $6.25 \text{ ft}^2 \times 50 \text{ ft} = 312.5 \text{ ft}^3$.
= 11.57 cubic yards

11.57 yds³ is the overburden ratio (as $1 \text{ ft}^3 = 0.037037$ cubic yards)

Since the recovery of coal is 80% (0.80), so it must be incorporated in the overburden ratio.

- $11.57 / 0.80 = 14.46$ cubic yds/ton

Determine the overburden ratio by considering the example-02 and overburden cover of 80 ft.

Solution:

- 1 ton of coal occupies the volume of 26.92 ft³.
- 6 ft. thick coal seam occupies the area of $26.92 / 6 = 4.49$ ft².

Thus, the volume of overburden above 1 ton of coal = $4.49 \times 80 = 358.93 \text{ ft}^3$.
= 13.29 cubic yards

13.29 yds³ is the overburden ratio.

9. INITIAL DATA COLLECTION CHECKLIST

1. Topography

- Survey of Pakistan Maps (Topo Sheets)
- Aerial photographs
- Satellite imageries

2. Climate conditions

- Altitude
- Temperatures
- Rainfall
- Flood
- Wind (speed and direction)
- Humidity
- Dust
- Fog and cloud conditions

3. Water (potable/drinkable)

- Sources
- Availability
- Quantities
- Quality
- Sewage disposal

4. Geologic structure

5. Mine water

- Depth
- Quantity
- Method of drainage

6. Surface

- Vegetation
- Unusual conditions

7. Rock type

- Overburden
- Interburden

8.Roads

9.Power

10.Land ownership

11. Waste dump location

10. PLANNING PHASE

Planning phase involves three stages:

10.1 Conceptual study

In this stage, the project idea is transformed into a broad investment proposition. It includes scope of work, definition and cost estimate. Capital and operating costs of the project are estimated using historical data. It is a work of one or two engineers.

10.2 Preliminary or pre-feasibility study

The main objective of a pre-feasibility study is to determine whether the project concept justifies the detailed feasibility study. It is conducted by a group of experts

10.3 Feasibility study

It provides a definitive technical, financial and environmental base for an investment decision. It identifies production capacity, technology, investment, production costs, sales revenues and returns on investment.

10.3.1 Contents of Feasibility Study

1. General

- Topography
- Climate
- Population
- Access
- Services
- Sites for waste dump, plant, township etc.

2. Geological (field)

- Geological study of structure and mineralization
- Sampling by drilling or tunneling
- Bulk sampling for metallurgical testing
- Rock properties, strength, stability and assaying

3. Geological and mining (Office)

- Checking, correcting and coding of data for computer input
- Manual calculations of ore tonnages and grades.
- Assay compositing and statistical analysis
- Computation of mineral inventory (geological reserves) and minable reserves by ore body, by ore type, by elevation or bench and by grade categories.
- Computation of associated waste rock
- Derivation of the economic factors used in the determination of minable reserves

4. Mining

- Open pit layouts and plans
- Determination of development requirements
- Estimation of waste *rock dilution* and ore losses
- Production and stripping schedules and identifying important changes in ore types
- Waste mining and waste disposal.

- Determine the equipment requirements, their cost and replacement schedule for the major equipment
- Determine the labor requirements

5.Ancillary services

- Access, transport, power, water, fuel and communications
- Workshops, offices, laboratories, sundry buildings and equipment
- Housing and transport of employees
- Labor structure and strength
- Other social requirements

6.Capital cost estimation

- Develop the mine concepts and make all necessary drawings
- Estimate the equipment cost
- Calculate all important quantities of excavation, concrete, building area, pipe work etc.
- Determine a provisional (temporary) construction schedule
- Obtain quotations of the direct cost of machinery items.
- Establish the costs of materials, services, labor and installation
- Determine the various indirect costs including freight (transport in bulk) and taxes on equipment, field office, supervision, travel, design cost, licenses, custom duties and sales tax.
- Warehouse (storeroom) inventories (lists)
- Contingency allowance for unforeseen
 - Contingency is a future event or circumstance which is possible but cannot be predicted with certainty.
- Operating capital, sufficient to pay for running the mine until the first revenue is received
- Financing cost

7.Operating cost estimation

- Define the labor strength, basic pay and fringe (marginal) costs

- Establish the quantities of important measurable supplies to be consumed including power, explosives, fuel, reagents etc. and their unit costs.
- Determine the hourly operating and maintenance costs and performance factors
- Estimate the fixed administration costs and other overheads (expenses)
- Maintenance of township and social costs

8.Rights, ownership and legal matters

- Mineral rights and tenure
- Mining rights if not included in mineral rights
- Royalties
- Property acquisition
- Surface rights for land, water etc.
- Licenses and permits for construction and operation
- Employment laws for local and expatriate employees.
- Agreements between partners
- Legal features of tax, currency exchange and financial matters.
- Company incorporation

9.Environmental effects

- Environmental study and report incorporating pollution control
- Plans for restoration (reclamation) of the area after mining

10.Revenue and profit analysis

- Mine production schedules and year-by-year output of products
- Net revenue (income) at the mine
- Calculation of annual costs
- Calculation of complete cash flow schedule with depreciation (adjusted cost basis) and taxes for a complete life of a mine
- Presentation of totals and summaries of results
- Calculation of rate of return, payback, profit etc.
- Sensitivity analysis on the basis of prices and important input elements

11. OREBODY DESCRIPTION

Mine Maps: The fundamental documents in all stages of mine planning and design are the maps. Maps are essential for:

- Collecting
- Outlining
- Correlating

Scale of map: Maps are drawn to various scales. Scale is the ratio between the linear distances on the map and the corresponding distances on the ground.

Example:

- In the English system, for example, the scale of 1:200 means that an actual distance of 200 ft. is represented by a length of 1 inch on the map.
- In the Metric system, for example, 1:1000 scale means 1000 m of actual distance on the ground is represented by a 1 m distance on the map.

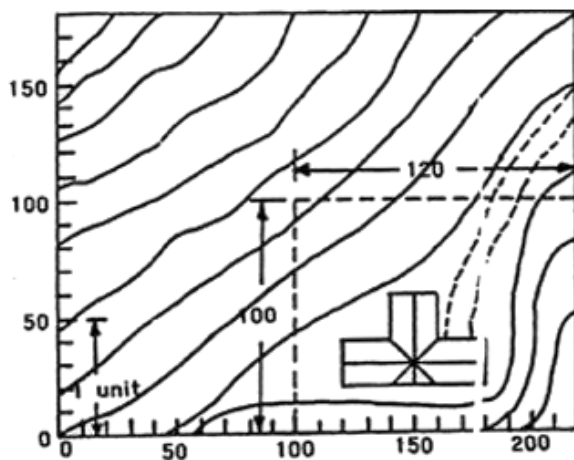

Small Scale, 1:50

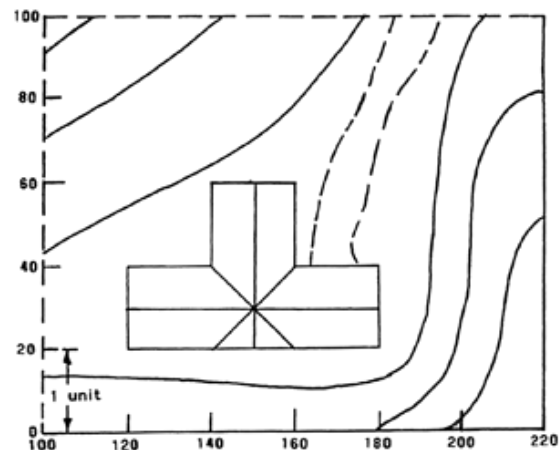

Large Scale, 1:20

Selection of the scale

Selection of the most appropriate scale depends upon:

- Size of the area to be represented
- Intended uses of the map

Appropriate scale for mine planning

Scale should be such that keeps the whole pit on one sheet.

Common planning scales are:

- In English system:
 - 1 inch = 100 ft.
 - 1 inch = 200 ft.
- In metric system:
 - 1 m = 1000 m
 - 1 m = 2000 m

Scale for Geologic Mapping

Geologic mapping is commonly done on larger scale, such as:

- 1 inch = 40 ft.
- 1 m = 500 m

Features of Mine Map

Mine map is a map of medium scale. Features may include:

- Mine structures
- Power lines
- Water supply
- Access roads
- Railway lines
- Conveyor lines
- Pipe lines
- Dump location
- Location of ore body
- Location of drill holes
- Property ownership and control

12. ORE RESERVE CALCULATION

The estimation of ore reserves is a process that begins with the earliest exploration stages on a property and continues throughout exploitation of the deposit. During exploration and preliminary evaluation, the results of these reserve estimates constitute the basic data for pre-feasibility studies and economic analysis.

During the active life of a mine, reserve computations are continuously revised to assist in development planning, cost and efficiency analyses, quality control, and improvement of extraction and processing methods. Accurate reserve estimates are also required when financing a project, purchasing or selling a property, and for accounting purposes.

The reliability of ore reserve estimates varies progressively through time as more and more information becomes available. The lowest order of reliability of estimation of reserves exists at the time of discovery. The maximum level of certainty concerning the ore reserves within a deposit is reached when the deposit is completely mined out. Between these two extremes are variable levels of certainty as to the tonnage and grade of the resource.

12. 1 Classification of Ore Reserves

Ore reserves are classified with respect to the confidence level of the estimate. Traditionally, ore reserves have been classified as:

- proven (measured),
 - computed from sample analysis and measurement from closely drill holes; less than or equal to one mile
 - the point of observation (distance between drill holes) should not be more than one mile (1,609.34 meters).
- probable (indicated),
 - the distance between observational points should be greater than one mile and less than or equal to two miles.
- possible (inferred).
 - These estimations are based on assumed continuity and the similarity of the beds and knowledge of the geological characteristics of the deposits.

Inferred ore reserve may or may not be supported by samples and measurement.

- the observational points must be in between 2 to 6 miles.

The mining reserve is always less than or equal to the geologic reserve estimate because a variable proportion of the orebody must be left unmined for a variety of reasons. These reasons include the need for pillars for ground support, metallurgical problems, width of mineralization, or other economic and engineering factors.

12.2 Ore Reserve Parameters

An ore reserve estimate contains two important parameters:

- the amount of ore and
- the average grade or value of that ore.

In metal mines, the amount of ore is usually expressed in either metric tons (1000 kg) or short tons (2000 lb). Grades are normally expressed as a percentage for base metal ores, whereas precious metals may be reported as troy ounces per ton, penny-weights per ton, or grams/metric ton.

12.2.1 Tonnage Determination

Tonnage Factor Calculation: The tonnage factor provides the mechanism for the conversion from the volume of ore to the weight of ore. In the English system, the tonnage factor is normally expressed as cubic feet per ton of ore. In the metric system, the tonnage factor is the specific gravity of the ore. The tonnage factor is dependent upon the specific gravity of the ore.

12.2.2 Grade Determination

The average grade of an ore deposit or of a specific block within a deposit is based on assays of samples collected within the block or deposit. Sample collection, preparation, and analysis are often the most critical operations in evaluating the reserves for a mineral property.

12.2.2.1 Cutoff Grade:

The cutoff grade is the minimum ore grade that can be mined at a profit under economic conditions existing at a particular point in time. The cutoff grade can vary with time due to changes in such factors as commodity prices, operating costs, and taxes. The cutoff grade used for any reserve calculation should always be stated.

Grade Calculation

Weighted average grade

One of the most frequent calculations are weightings, e.g. for the calculation of the

- average grade of a drill hole from assay intervals of different lengths or
- average grade of a deposit from the combined grades of individual, unequal blocks.

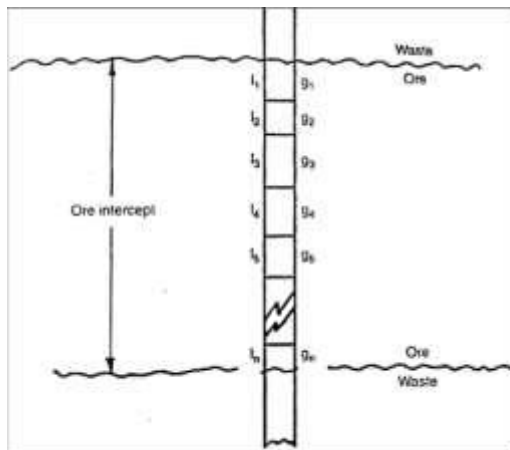

Fig. Ore intercept compositing

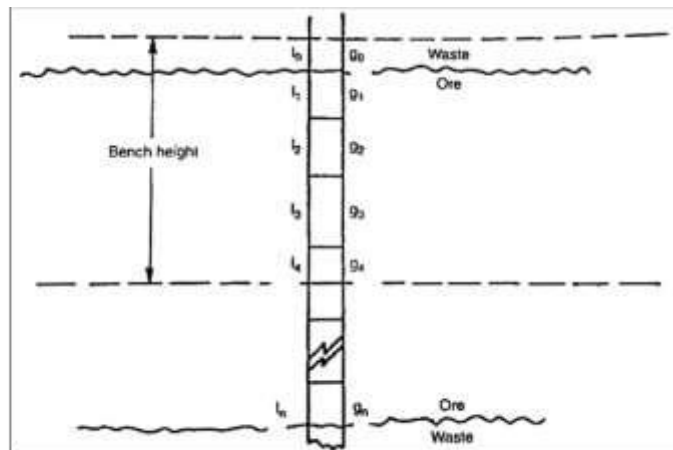

Fig. Bench height compositing

| Given | | Calculated |
|------------|-----------|----------------|
| Length | Grade | Length x Grade |
| l_1 | g_1 | $l_1 g_1$ |
| l_2 | g_2 | $l_2 g_2$ |
| l_3 | g_3 | $l_3 g_3$ |
| l_n | g_n | $l_n g_n$ |
| $\sum l_i$ | \bar{g} | $\sum l_i g_i$ |

$$\bar{g} = \frac{l_1 \cdot g_1 + l_2 \cdot g_2 + \dots + l_n \cdot g_n}{l_1 + l_2 + \dots + l_n} \Rightarrow \bar{g} = \frac{\sum l_i g_i}{\sum L_i}$$

Example: The analytical results from unequal, but consecutive intervals are provided in the following Table for Lead ore. What is the weighted mean?

| Sample Interval (m) | Grade (% Pb) | Length x Grade |
|---------------------|--------------|----------------|
| 1 | 2.1 | 2.1 |
| 1.5 | 8.4 | 12.6 |
| 0.75 | 12 | 9 |
| 1.25 | 10.2 | 12.75 |
| 4.5 | | 36.45 |

$$\bar{g} = \frac{1 \times 2.1 + 1.5 \times 8.4 + 0.75 \times 12 + 1.25 \times 10.2}{1 + 1.5 + 0.75 + 1.25} = \frac{36.45}{4.5} = 8.10 \%$$

For a large, uniform deposits where the transition (change) from ore to waste is gradual, the compositing interval is the bench height. This bench compositing is the most used method for resource modeling in open pit mining.

| Length | Grade | Length x Grade |
|--------|-------|----------------|
| l_1 | g_1 | l_1g_1 |
| l_2 | g_2 | l_2g_2 |
| l_3 | g_3 | l_3g_3 |
| l_n | g_n | $l_n g_n$ |

$$\sum l_i \qquad \qquad \qquad \sum l_i g_i$$

$$\sum l_i = H$$

$$\sum l_i = H$$

Where, H is bench height. Hence,

$$\bar{g} = \frac{\sum l_i g_i}{H}$$

Calculate the average grade of an ore having following data

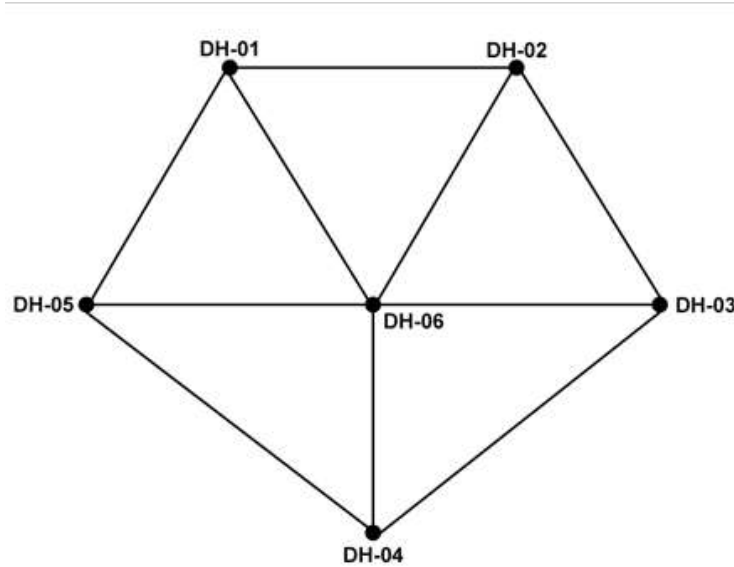

| | | |
|-------|--|-------|
| DH-01 | | t1 g1 |
| DH-02 | | t2 g2 |
| DH-03 | | t3 g3 |
| DH-04 | | t4 g4 |
| DH-05 | | t5 g5 |
| DH-06 | | t6 g6 |

| Hole ID | Length (m) | Grade (%) |
|---------|------------|-----------|
| DH-01 | 0.6 | 0.59 |
| DH-02 | 1.4 | 0.48 |
| DH-03 | 1.4 | 0.60 |
| DH-04 | 1.4 | 0.56 |
| DH-05 | 1.3 | 0.32 |
| DH-06 | 1.2 | 0.63 |

Solution:

$$\bar{g} = \frac{l_1 \cdot g_1 + l_2 \cdot g_2 + \dots + l_n \cdot g_n}{l_1 + l_2 + \dots + l_n}$$

$$\bar{g} = 0.523\%$$

Calculate ore grade by inverse distance weighting technique by following data.

DH1 (0.409)

DH2 (0.165)

DH3 (0.258)

DH4 (1.365)

DH5 (0.023)

DH6 (0.644)

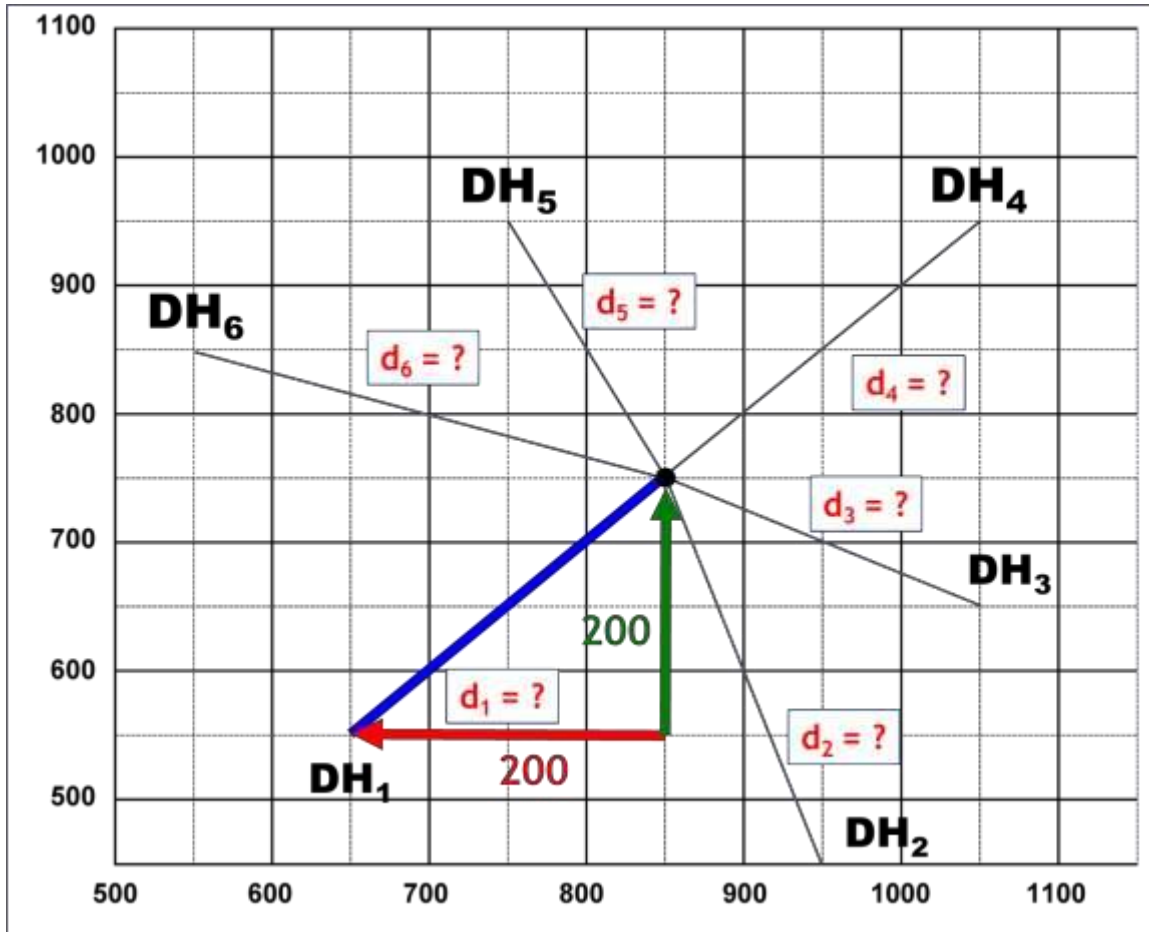

Pythagorean Theorem tells us that the relationship in every right triangle is: $a^2+b^2=c^2$

$$\bar{g} = \frac{\sum \frac{g_i}{d_i}}{\sum \frac{1}{d_i}}$$

Determine the thickness of ore body at point c using the drill hole data of C1 to C11. Grid dimensions are 1mx1m

- d1 = 3 m
- d2 = 3.61 m
- d3 = 3.16 m
- d4 = 4.24 m
- d5 = 2.24 m
- d6 = 3.16 m
- d7 = 4.24 m
- d8 = 4.12 m
- d9 = 4.47 m
- d10 = 4.24 m
- d11 = 2.24 m

C= 18.41 m

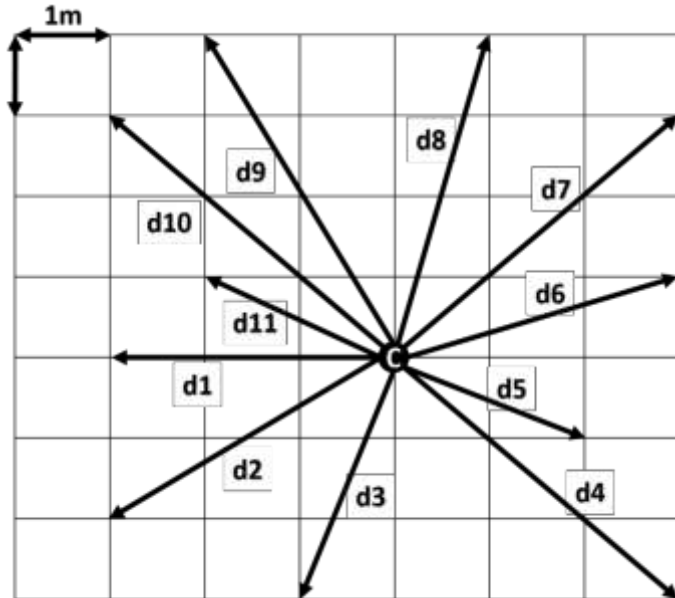

Calculation of average grade using constant distance weighting technique

This method is called simple *inverse distance* weighting technique.

$$g = \frac{\sum_{i=1}^n \frac{g_i}{d_i}}{\sum_{i=1}^n \frac{1}{d_i}}$$

g_i = given grade at distance d_i away from desired point.

Note: The grade of the block should be more similar to nearer points than those far away.

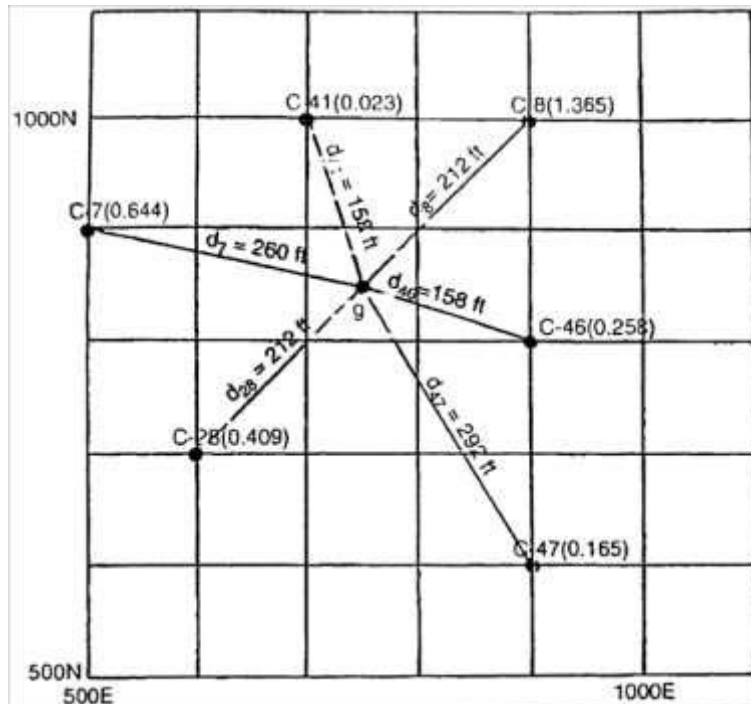

100ft X 100ft block grid

$$g = \frac{\frac{0.644}{260} + \frac{0.023}{158} + \frac{1.365}{212} + \frac{0.258}{158} + \frac{0.165}{292} + \frac{0.409}{212}}{\frac{1}{260} + \frac{1}{158} + \frac{1}{212} + \frac{1}{158} + \frac{1}{292} + \frac{1}{212}} = 0.45\%$$

Calculation of average grade using Inverse Distance Squared (IDS) weighting technique

$$g = \frac{\sum_{i=1}^n \frac{g_i}{d_i^2}}{\sum_{i=1}^n \frac{1}{d_i^2}}$$

Answer will be 0.54%.

Note: To select a different power for distance (d), the results would change.

Calculation of the area of a triangle

In the triangular method, each hole is taken to be at one corner of a triangle. The area of a triangle can be found through calculation if the coordinates (x_i, y_i) of the corners are known.

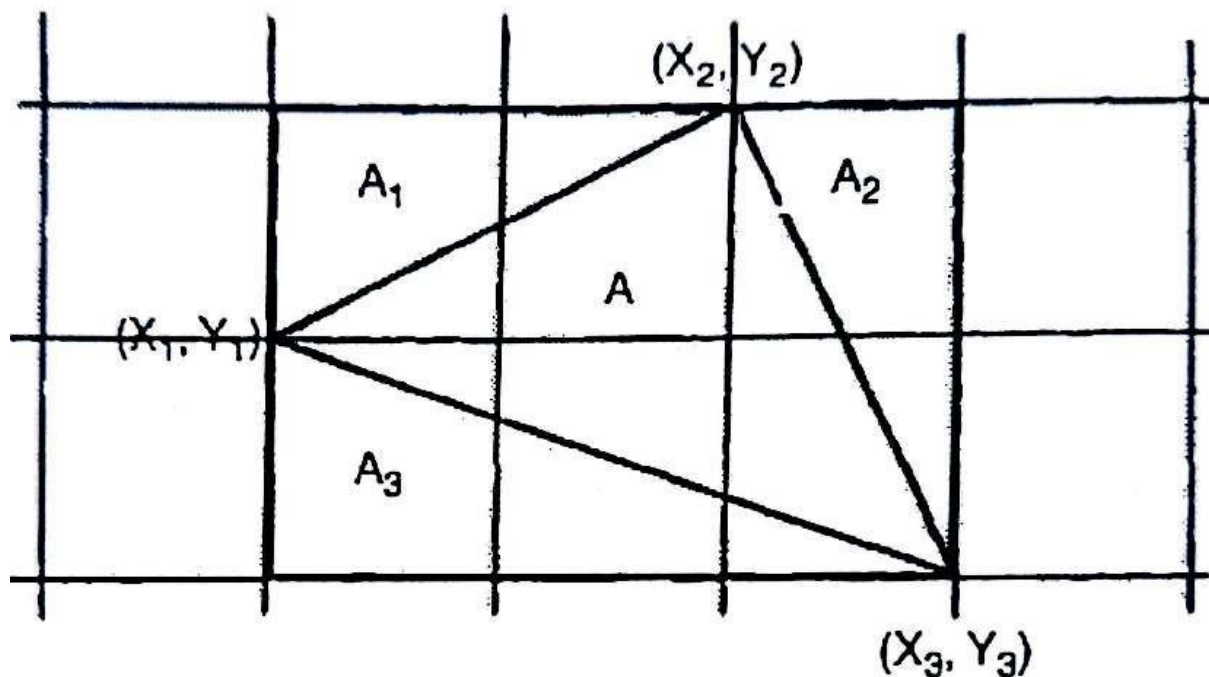

$$a_1 = \frac{1}{2} (X_2 - X_1) (Y_2 - Y_1)$$

$$a_2 = \frac{1}{2} (X_3 - X_2) (Y_2 - Y_3)$$

$$a_3 = \frac{1}{2} (X_3 - X_1) (Y_1 - Y_3)$$

- Area of a rectangle = $(X_3 - X_1) (Y_2 - Y_3)$

$$\text{Total Area (A)} = \text{Area of a rectangle} - a_1 - a_2 - a_3$$

$$A = (X_3 - X_1) (Y_2 - Y_3) - \frac{1}{2} (X_2 - X_1) (Y_2 - Y_1) - \frac{1}{2} (X_3 - X_2) (Y_2 - Y_3) - \frac{1}{2} (X_3 - X_1) (Y_1 - Y_3)$$

Example: Determine the area of a triangle having the following coordinates:

- $(X_1, Y_1) = (1, 1)$
- $(X_2, Y_2) = (3, 2)$
- $(X_3, Y_3) = (4, 0)$

Solution:

$$A = (X_3 - X_1) (Y_2 - Y_3) - \frac{1}{2} (X_2 - X_1) (Y_2 - Y_1) - \frac{1}{2} (X_3 - X_2) (Y_2 - Y_3) - \frac{1}{2} (X_3 - X_1) (Y_1 - Y_3)$$

$$A = (4 - 1) (2 - 0) - \frac{1}{2} (3 - 1) (2 - 1) - \frac{1}{2} (4 - 3) (2 - 0) - \frac{1}{2} (4 - 1) (1 - 0)$$

$$A = 2.5 \text{ m}_2$$

Example: Determine the reserves of a deposit. Data is given in the following table. Density of the ore is 2.5 tons/m³.

| Drill hole | Easting (m) | Northing (m) | Thickness (m) | Grade (%) |
|------------|-------------|--------------|---------------|-----------|
| C1 | 0 | 2 | 2 | 0.6 |
| C2 | 1 | 7 | 3 | 0.55 |
| C3 | 5 | 8 | 3 | 0.5 |
| C4 | 7 | 3 | 2.5 | 0.6 |
| C5 | 4 | 0 | 1.5 | 0.45 |
| C6 | 3 | 4 | 2.5 | 0.5 |

X = Easting, Y = Northing

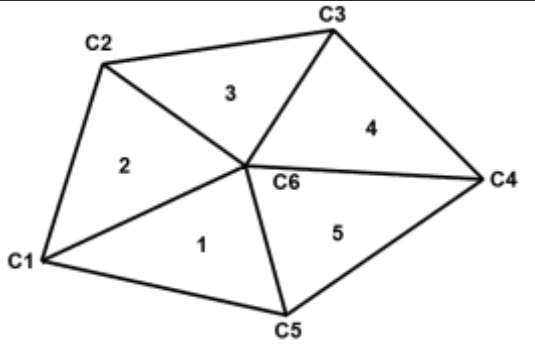

$$\text{Area of a rectangle} = (X_3 - X_1) (Y_2 - Y_3) \rightarrow (4-0)(4-0) \rightarrow 16$$

$$a_1 = \frac{1}{2} (X_2 - X_1) (Y_2 - Y_1) \rightarrow \frac{1}{2} (3-0)(4-2) \rightarrow \frac{1}{2} (3)(2) \rightarrow 3$$

$$a_2 = \frac{1}{2} (X_3 - X_2) (Y_2 - Y_3) \rightarrow \frac{1}{2} (4-3)(4-0) \rightarrow \frac{1}{2} (1)(4) \rightarrow 2$$

$$a_3 = \frac{1}{2} (X_3 - X_1) (Y_1 - Y_3) \rightarrow \frac{1}{2} (4-0)(2-0) \rightarrow \frac{1}{2} (4)(2) \rightarrow 4$$

$$\Delta C_1C_6C_5 = (x_3 - x_1)(y_2 - y_3) - \frac{1}{2}(x_2 - x_1)(y_2 - y_1) - \frac{1}{2}(x_3 - x_2)(y_2 - y_3) - \frac{1}{2}(x_3 - x_1)(y_1 - y_3)$$

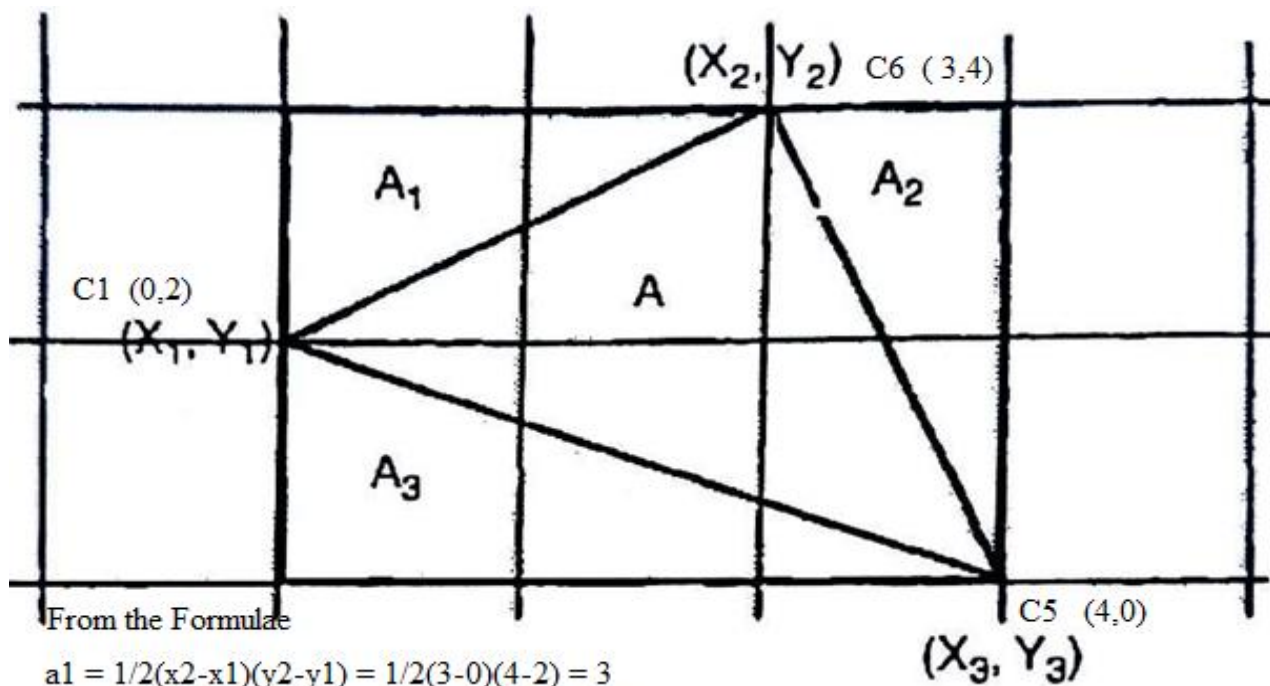

From the Formulae

$$a_1 = 1/2(x_2 - x_1)(y_2 - y_1) = 1/2(3 - 0)(4 - 2) = 3$$

$$a_2 = 1/2(x_3 - x_2)(y_2 - y_3) = 1/2(4 - 3)(4 - 0) = 2$$

$$a_3 = 1/2(x_3 - x_1)(y_1 - y_3) = 1/2(4 - 0)(2 - 0) = 4$$

$$\text{Rectangle} = (x_3 - x_1)(y_2 - y_3) = (4 - 0)(4 - 0) = 16$$

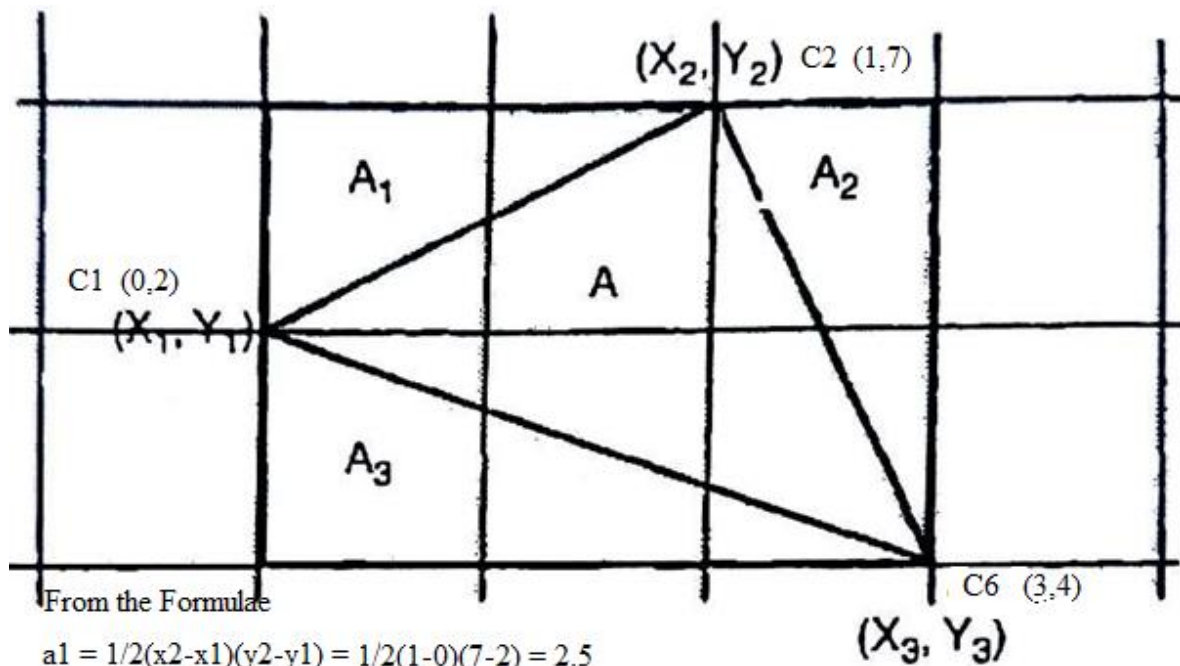

From the Formulae

$$a_1 = 1/2(x_2 - x_1)(y_2 - y_1) = 1/2(1 - 0)(7 - 2) = 2.5$$

$$a_2 = 1/2(x_3 - x_2)(y_2 - y_3) = 1/2(3 - 1)(7 - 4) = 3$$

$$a_3 = 1/2(x_3 - x_1)(y_3 - y_1) = 1/2(3 - 0)(4 - 2) = 3$$

$$\text{Rectangle} = (x_3 - x_1)(y_2 - y_1) = (3 - 0)(7 - 2) = 15$$

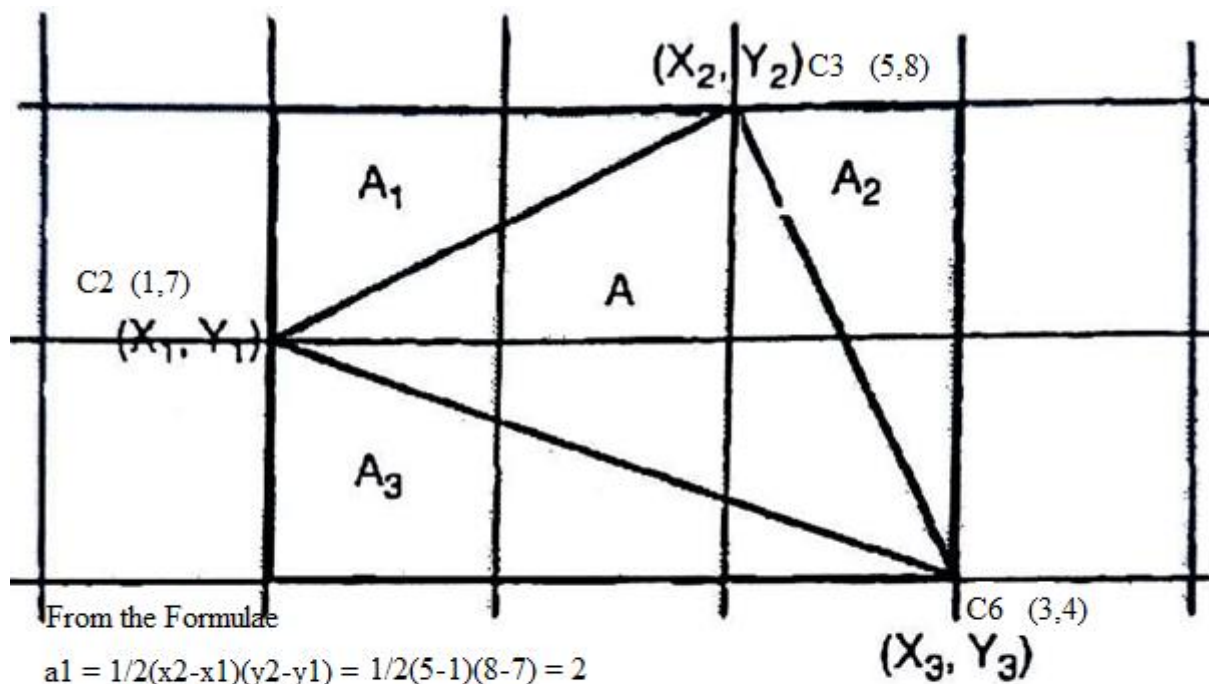

From the Formulae

$$a_1 = 1/2(x_2-x_1)(y_2-y_1) = 1/2(5-1)(8-7) = 2$$

$$a_2 = 1/2(x_2-x_3)(y_2-y_3) = 1/2(5-3)(8-4) = 4$$

$$a_3 = 1/2(x_3-x_1)(y_1-y_3) = 1/2(3-1)(7-4) = 3$$

$$\text{Rectangle} = (x_2-x_1)(y_2-y_3) = (5-1)(8-4) = 16$$

$\Delta C_1 C_6 C_5 =$ Area of a rectangle – $a_1 - a_2 - a_3$

$$\Delta C_1 C_6 C_5 = 16 - 3 - 2 - 4$$

$$A1 (\Delta C_1 C_6 C_5) = 7 \text{ m}^2$$

$$\Delta C_1 C_6 C_2 = (x_3 - x_1)(y_2 - y_3) - \frac{1}{2}(x_2 - x_1)(y_2 - y_1) - \frac{1}{2}(x_3 - x_2)(y_2 - y_3) - \frac{1}{2}(x_3 - x_1)(y_1 - y_3)$$

$$A2 = 6.5 \text{ m}^2$$

$$\Delta C_2 C_6 C_3 = (x_3 - x_1)(y_2 - y_3) - \frac{1}{2}(x_2 - x_1)(y_2 - y_1) - \frac{1}{2}(x_3 - x_2)(y_2 - y_3) - \frac{1}{2}(x_3 - x_1)(y_1 - y_3)$$

$$A3 = 7 \text{ m}^2$$

$$\Delta C_3 C_6 C_4 = (x_3 - x_1)(y_2 - y_3) - \frac{1}{2}(x_2 - x_1)(y_2 - y_1) - \frac{1}{2}(x_3 - x_2)(y_2 - y_3) - \frac{1}{2}(x_3 - x_1)(y_1 - y_3)$$

$$A4 = 9 \text{ m}^2$$

$$\Delta C_4 C_6 C_5 = (x_3 - x_1)(y_2 - y_3) - \frac{1}{2}(x_2 - x_1)(y_2 - y_1) - \frac{1}{2}(x_3 - x_2)(y_2 - y_3) - \frac{1}{2}(x_3 - x_1)(y_1 - y_3)$$

$$A5 = 7.5 \text{ m}^2$$

• T_1 (Average thickness of $\Delta C_1 C_6 C_5$) = $\frac{\text{Thickness of } (C_1 C_6 C_5)}{3}$

- $T1 = (2+2.5+1.5)/3 = 2 \text{ m}$
- $T2 = (2+3+2.5)/3 = 2.5 \text{ m}$
- $T3 = (3+3+2.5)/3 = 2.83 \text{ m}$
- $T4 = (3+2.5+2.5)/3 = 2.67 \text{ m}$
- $T5 = (2.5+2.5+1.5)/3 = 2.17$

$$V = A \times T$$

$$V = A_1 \times T_1 + A_2 \times T_2 + A_3 \times T_3 + A_4 \times T_4 + A_5 \times T_5$$

$$V = 7 \times 2 + 6.5 \times 2.5 + 7 \times 2.83 + 9 \times 2.67 + 7.5 \times 2.17$$

$$V = 90.365 \text{ m}^3$$

$$\text{Tonnage} = V \times \text{Density}$$

$$\text{Tonnage} = V \times \text{Density}$$

$$= 0.365 \times 2.5$$

$$= 225.91 \text{ tons}$$

CALCULATION OF AN AREA OF A TRIANGLE BY HERON'S FORMULA

$$A = \sqrt{s(s-a)(s-b)(s-c)}$$

$$s = \frac{a+b+c}{2}$$

$$a = \sqrt{(y_2 - y_1)^2 + (x_2 - x_1)^2}$$

$$b = \sqrt{(y_3 - y_2)^2 + (x_3 - x_2)^2}$$

$$c = \sqrt{(y_3 - y_1)^2 + (x_3 - x_1)^2}$$

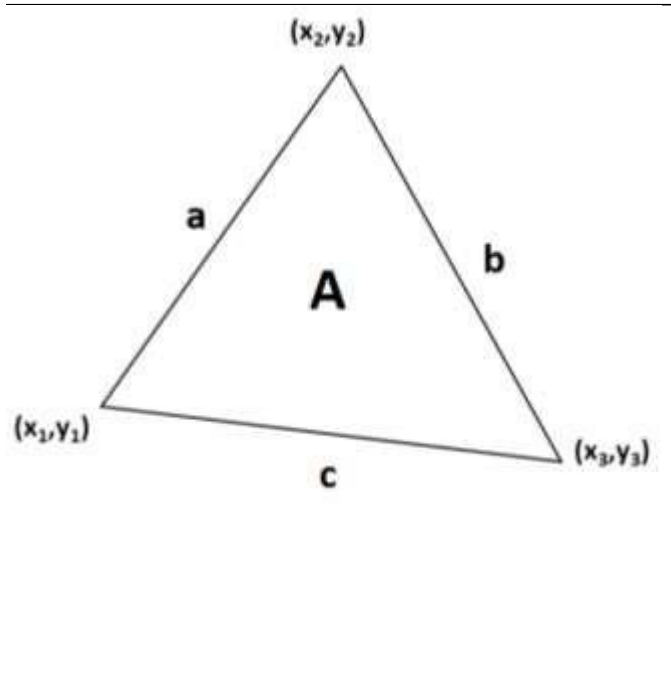

Determine the reserves of a deposit. Data is given in the following table. Density of ore is 2.6 tons/m³.

| Drill hole | Easting (m) | Northing (m) | Thickness (m) | Grade (%) |
|------------|-------------|--------------|---------------|-----------|
| D1 | 2 | 4 | 2.5 | 0.80 |
| D2 | 3 | 9 | 4 | 0.75 |
| D3 | 7 | 10 | 3 | 0.57 |
| D4 | 9 | 5 | 3.5 | 0.65 |
| D5 | 6 | 2 | 3 | 0.55 |
| D6 | 5 | 6 | 3 | 0.59 |

Tonnage Factor

The tonnage factor provides the mechanism for the conversion from the volume of ore to the weight of ore. In the English system, the tonnage factor is normally expressed as cubic feet per ton of ore.

In the metric system, the tonnage factor is the specific gravity of the ore. The tonnage factor is dependent upon the specific gravity of the ore, and the specific gravity is a function of the mineral composition of the ore.

$$TF = W/V$$

- TF = Tonnage Factor
- W = Weight of the material
- V = Volume of the material

13. GEOMETRICAL CONSIDERATIONS

The orebody is mined from the top down in a series of horizontal layers of uniform thickness called benches. Mining starts with top bench and after a sufficient floor area has been exposed, mining of the next layer can begin.

To access the different benches a road or ramp must be created. The width of the ramp depends upon the type of equipment to be accommodated.

13.1 Basic Bench Geometry

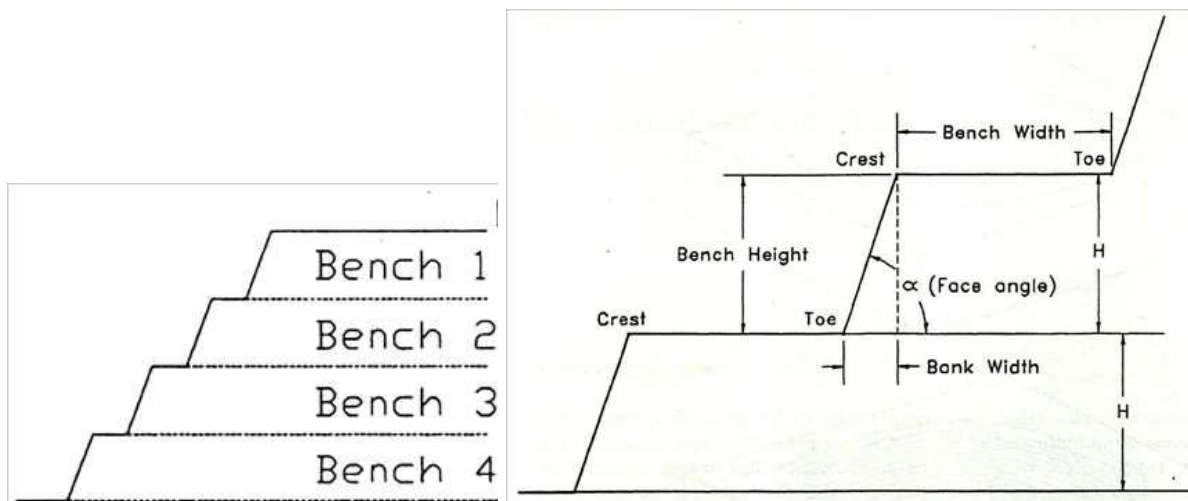

- **Bench height:** It is vertical distance between upper and lower surfaces of a bench.
- **Bench width:** It is a distance between the crest and the toe.
- **Face angle:** It is an inclination of a face of the bench w.r.t horizontal.

A working bench is one that is in the process of being mined.

Cut:

The width being extracted from the working bench is called the cut.

Width of working bench (W_B)

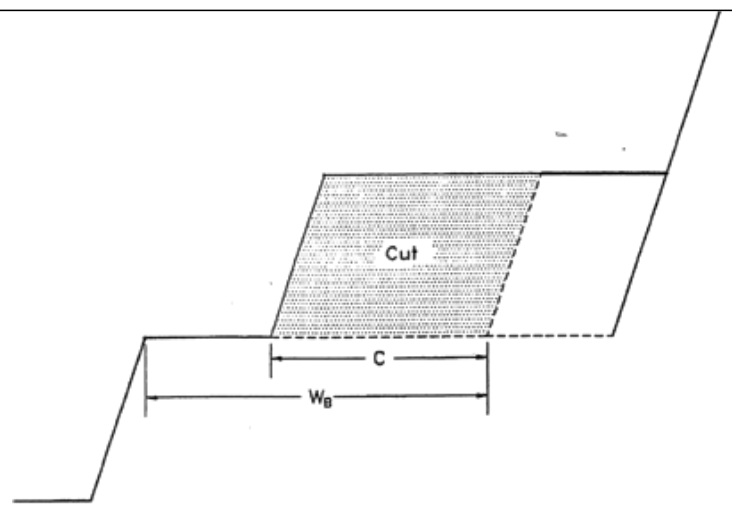

| | |
|--|--|
| <p>The distance between the crest of the bench and the new toe position after the cut has been made.</p> | <p>A section through a working bench</p> |
|--|--|

13.2 Ore Access

How does one begin the process of Mining?

Obliviously the approach depends upon the topography of the surrounding ground. To introduce the topic, it is assumed that the ground surface is flat. The overlying vegetation has been removed as has the soil/sand/gravel overburden. In this case, it will be assumed that the ore body is 700 feet in diameter, 40feet thick, flat dipping and is exposed.

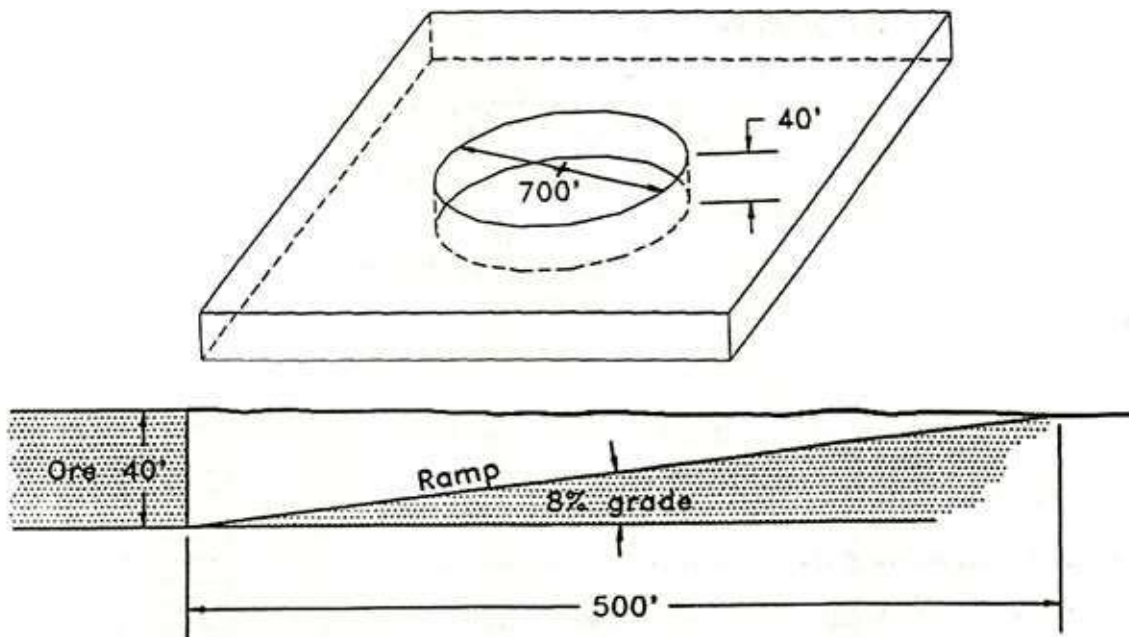

Ramp access

To access the orebody, the “ramp” shown in figure will be driven it has an 8% grade and a width of 65 feet.

A vertical digging face must be established in the ore body before major production can begin. Furthermore, a “ramp” must be created to allow truck and loader access.

The volume of access road or “ramp volume” is the volume of the waste rock mined in excavating the ramp.

$$B = \frac{100 \times H}{g}$$

B = Horizontal length of a ramp

H = Height of ramp

g = grade of ramp (%)

Example:

An ore body with 700 m in diameter and 4 m thick is to be excavated by a ramp in waste rock with 8% grade. Determine the horizontal length of a ramp.

H = 4 m

g = 8%

$$B = \frac{100 \times 4}{8} = 50 \text{ m}$$

The volume of access road or “ramp volume” is the volume of the waste rock mined in excavating the ramp.

∴ Ramp volume = Ramp width (R_w) × Area of Δabc .

$$\begin{aligned} \text{Ramp volume (V)} &= R_w \times \left[\frac{1}{2} \times B \times H \right] \\ &= R_w \times \left[\frac{1}{2} \times \left(\frac{H}{g} \times 100 \right) \times H \right] \\ &= R_w \times \frac{1}{2} \times \frac{H}{g} \times 100 \times H \end{aligned}$$

$$V = R_w \times \frac{H^2 \times 100}{2g}$$

$$V = R_w \times \frac{50 H^2}{g}$$

Example:

Determine the volume of ore body by a waste rock to develop access road at the slope of 8%. The depth of cylindrical ore body is 30 feet and diameter 500 ft, width of ramp is 65 feet.

Data:

Slope (g) = 8% Depth

(H) = 30 feet Diameter

(d) = 500 feet

Width of ramp (R_w) = 65 feet

Solution

As we know, Volume of ramp is equals to $50 (h^2/g) R_w$

$$V = 50 \times \frac{H^2}{g} R_w \rightarrow 50 \times \frac{30^2}{8} \times 65 \rightarrow 365625 \text{ ft}^3$$

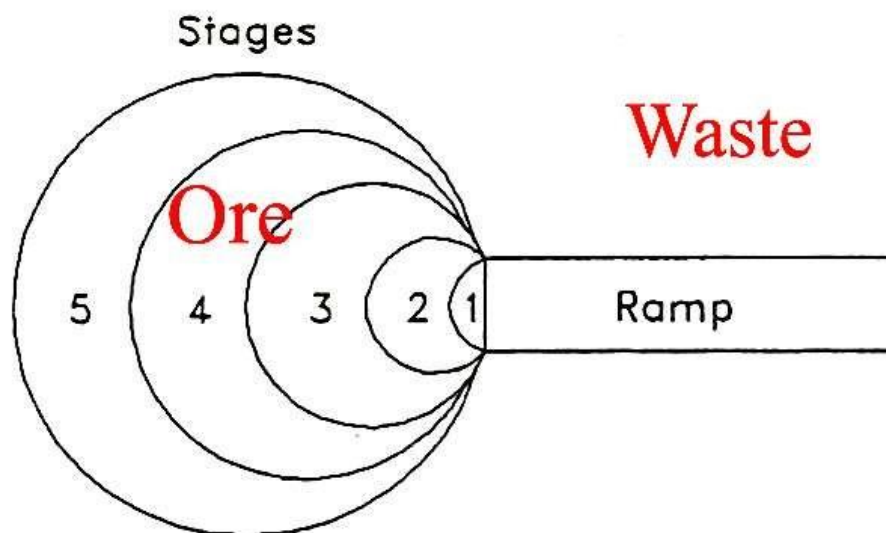
13.2.1 Development of Access Road: (Ramps)**i) Ramp located in waste rock**

ii) Ramp in ore body

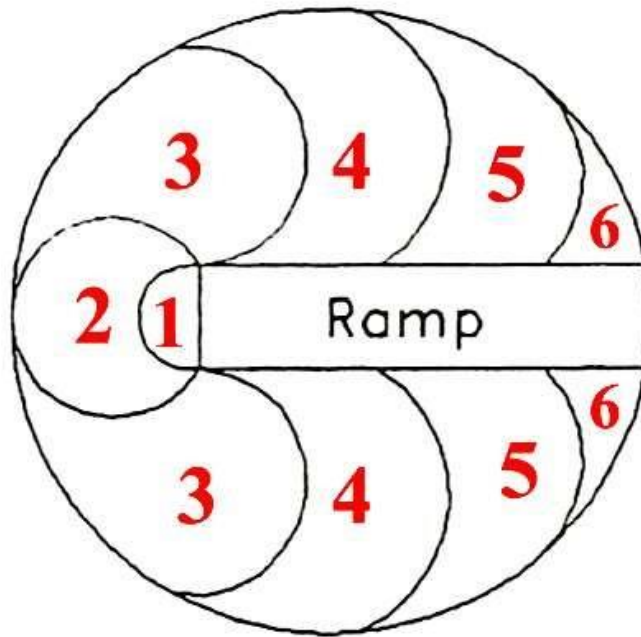

iii) Ramp starting in waste and ending in ore

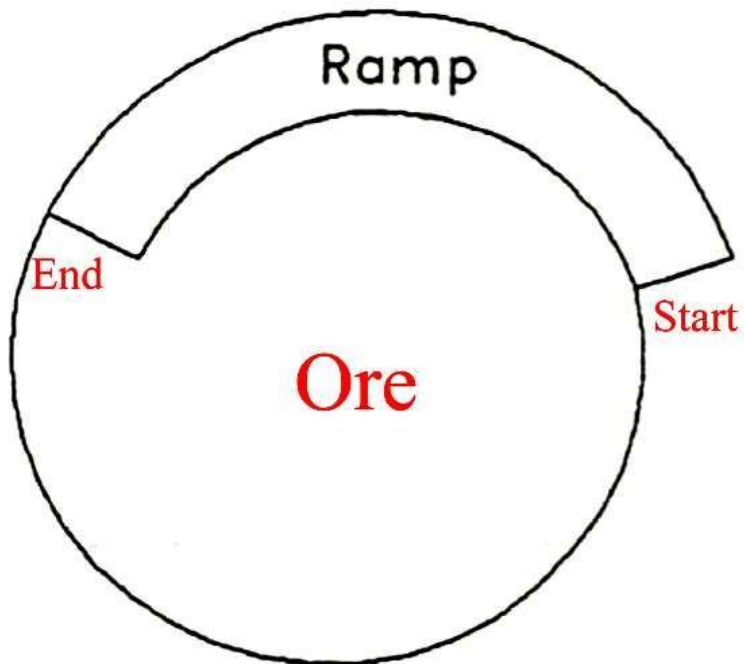

13.3 Approaches for face cutting

Once access has been established the cut is widened until the entire bench/level has been extended to the bench limits. There are three approaches which will be discussed here; they are as follows:

1. Frontal Cuts
2. Parallel Cuts – Drive by
3. Parallel Cuts – Turn & Back

The first two apply where there is a great deal of working area available, for example “at the pit bottom”. The mining of the narrower benches on the sides of the pit is covered under the third approach.

Frontal Cuts

The shovel faces the bench face and begins digging forward direction. The shovel first loads to the left and when the truck is full, it proceeds to the other truck on the right.

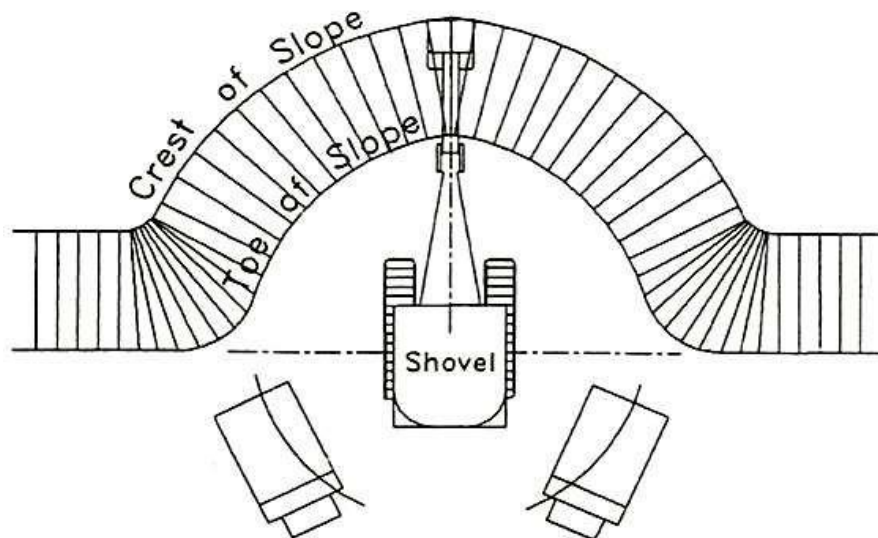

Diagrammatic representation of a frontal cutting operation.

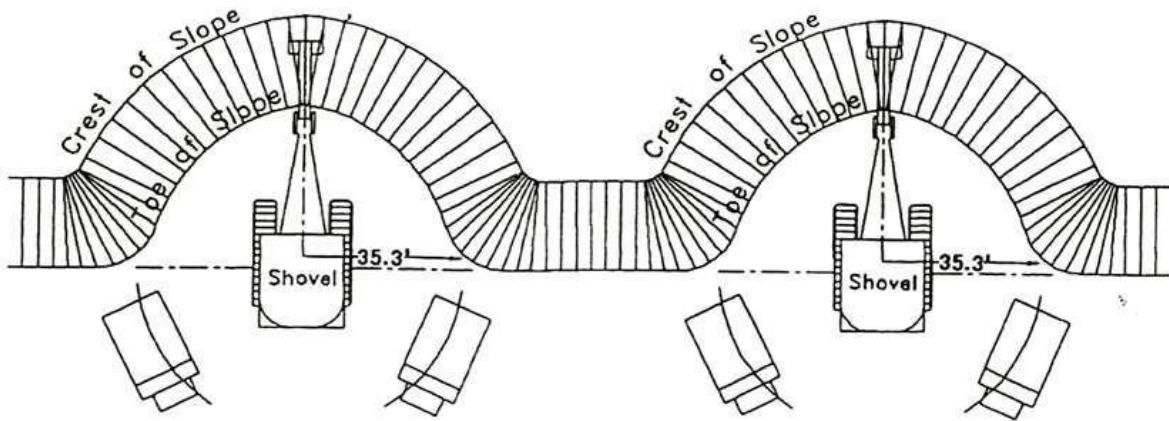

Two shovels working on the same face

Parallel Cuts

The shovel moves across and parallel to the digging face. For this case bench access for the haul units must be available from both the directions. It is highly efficient for both the trucks and the loader.

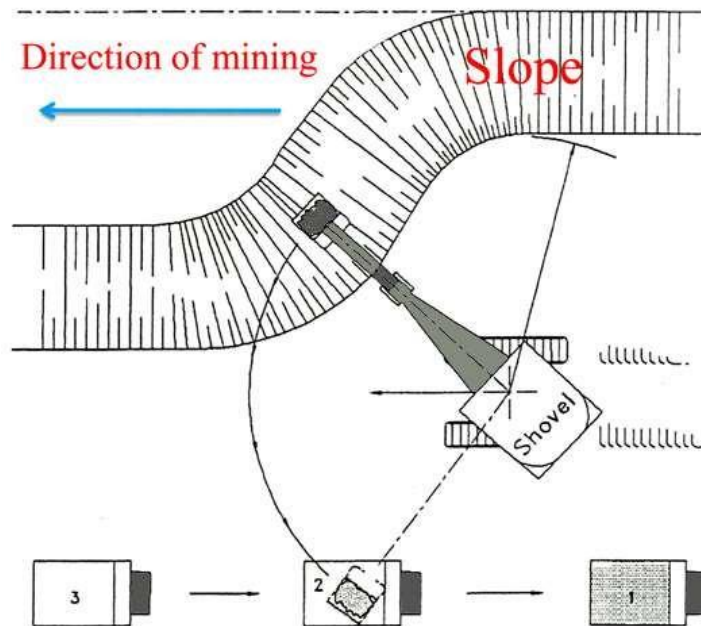

Parallel cut with drive-by

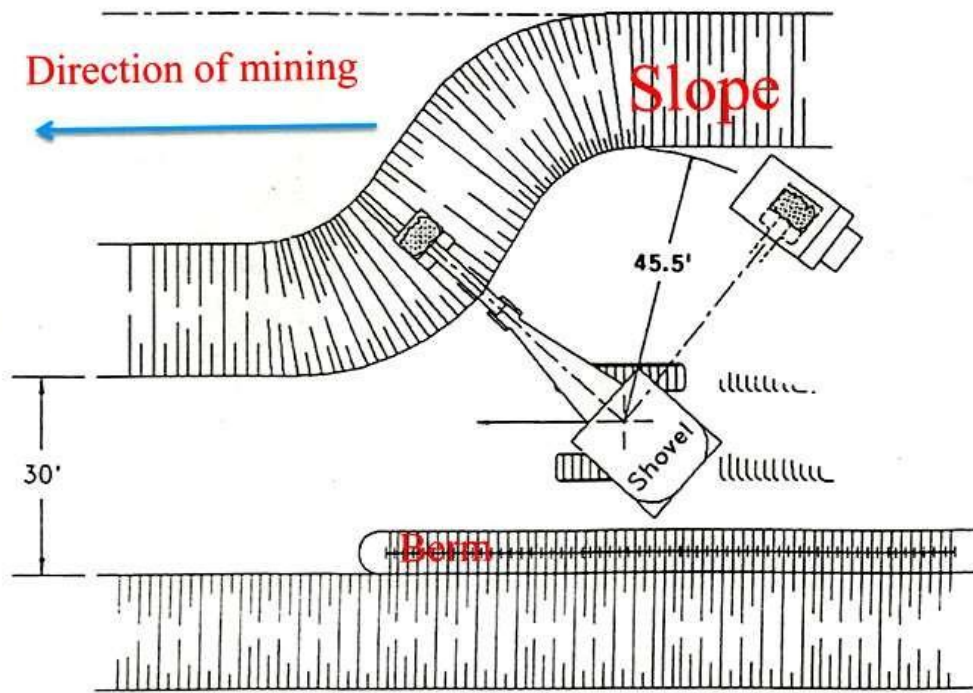

Parallel cut with the single spotting of trucks.

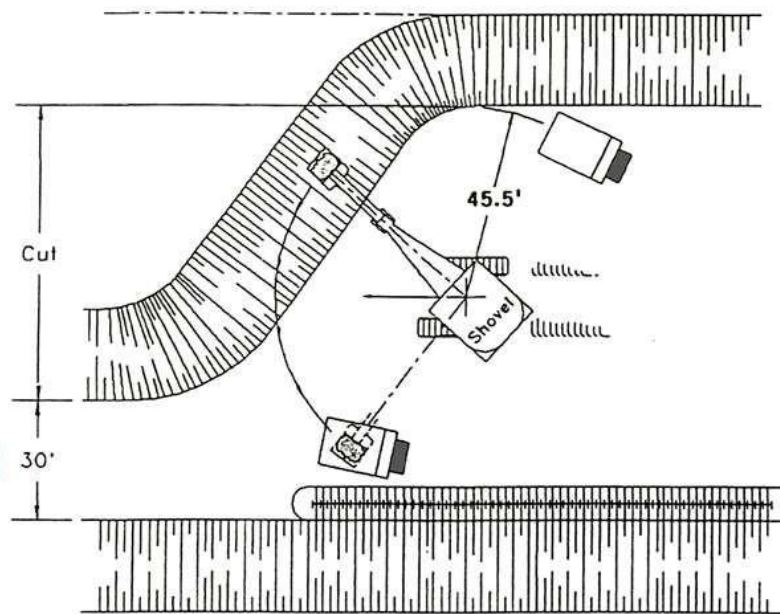

Parallel cut with the double spotting of trucks.

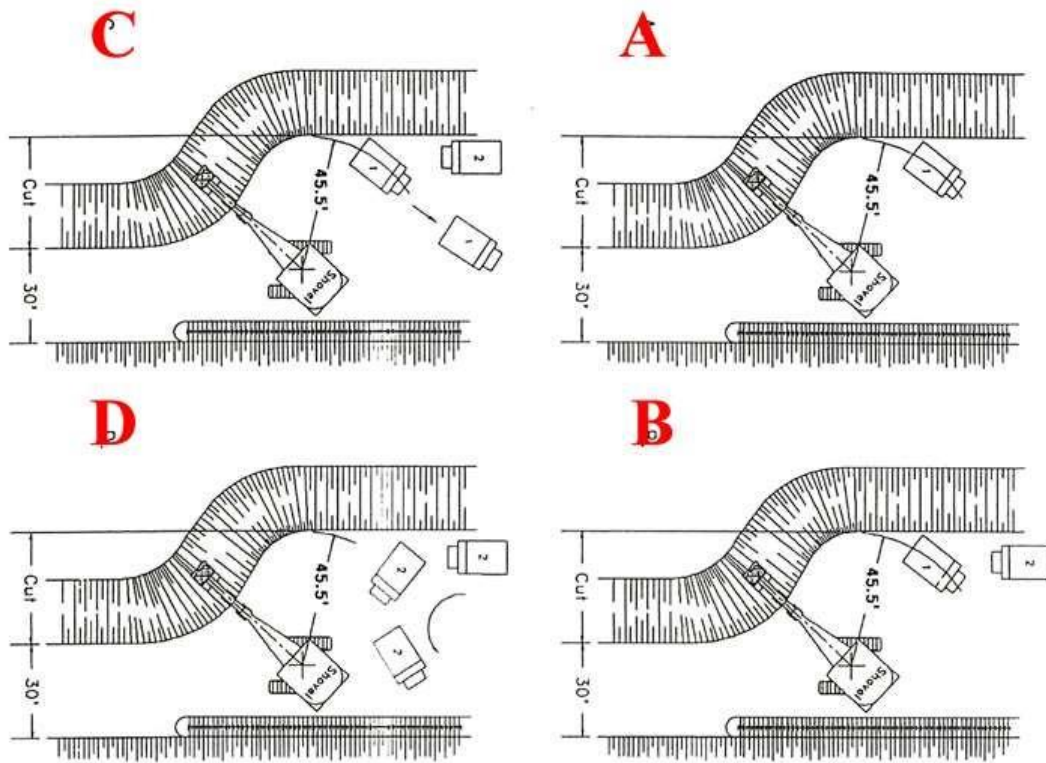

Time sequence of shovel loading

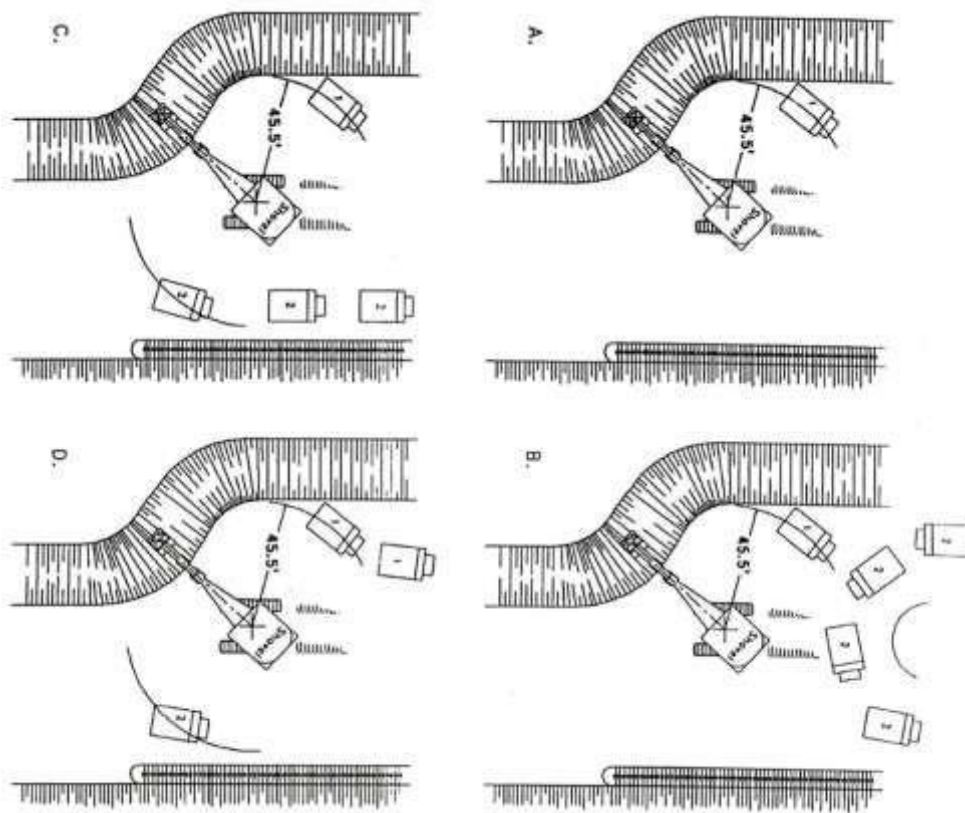

Shovel loading with double spotting

Reference Books:

1. E. P. PflEider, Surface Mining
2. B. A. Kennedy, Surface Mining, SME, 1990
3. William Hustrulid and M. Kuchta, Open pit Mine Planning and Design, Vol. I, April 2006, 2nd Edition. Taylor and Frances.
4. James W. Martin, Surface Mining Equipment

Instructor Name: Engr. Izhar Mithal Jiskani
Date: March 13, 2017
Department: Mining Engineering
Program: BS Mining Engineering
Session: Spring 2017
Semester: 6th
Admit Term: Fall 2014
Course Title: Surface Mine Design
Course Code: MINE-315
Credit Hours: 3

imjiskani@hotmail.com

Balochistan University of Information Technology, Engineering and
Management Sciences, Quetta, Pakistan.